



ARCHITECTURAL  
GRATES + DRAINS

2015<sup>+</sup>

Product Guide



# 2015<sup>+</sup>

## Stormtech Product Guide

### Contents

Product Selection Process	PAGE 1	Flow Rate + Hydraulic Guide	PAGE 52
Product Selector	PAGE 2-3	Maintenance + Care	PAGE 53

### Products

100 Range	PAGE 4-16	Vinyl Clamp Range	PAGE 47
65 Range	PAGE 17-40	Special Assembly Range	PAGE 48-49
38 Range	PAGE 41-43	Slot Drain Range	PAGE 50
Square Range	PAGE 44	Custom Fabrication	PAGE 51
Threshold Range	PAGE 45-46		



Stormtech has achieved Watermark Certification across our complete product range.

# Product Selection Process

## Choosing your Stormtech Drainage Product

1

### Product Range

Select a product range based on Stormtech standard width stainless steel grates or your custom width (see available specifications).

38

65

100

CUSTOM

2

### Grate Style

Choose a Stormtech designer grate finish or Tile Insert for your linear drainage style.

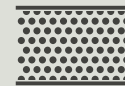
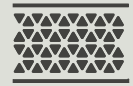

3

### Channel Material

Drainage channels and fittings are available in either uPVC or highly durable Stainless Steel.

uPVC

316  
GRADE

4

### Channel Depth

Choose from Stormtech's available standard channel depths (see Product Selector for Range/Depth combinations).

SEE SPECIFICATIONS FOR CUSTOM DEPTH.

21-25mm

26-35mm

40-45mm

CUSTOM

5

### Drain Length

Complete Kit  
Lengths up to 6000mm  
(see chosen product for available lengths)

Made-to-Length  
Specific length with custom outlet position  
for standard size products.

Custom Made  
For non-standard width/depth requirements.

Kit

Made to  
Length

CUSTOM

# Product Selector

Find the right Stormtech product.  
Match your preferred Grate + Range + Drain Depth + Kit Type.

## Drain Depth COLOUR GUIDE

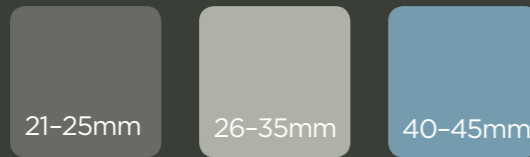

## AR Architectural

RANGE - WIDTH -	MODULAR KITS		MADE TO LENGTH - CUSTOM OUTLET -	FIXED-LENGTH - CENTRE OUTLET -
	uPVC Channel	Stainless Steel Channel	All Stainless Steel	All Stainless Steel
38mm	<b>38ARG40</b> PAGE 41		<b>38ARi40MTL</b> PAGE 41	
65mm	65ARG25 PAGE 18	65ARi25 PAGE 18	65ARi25MTL PAGE 17	65ARiCO25 PAGE 17
	<b>65ARG40</b> PAGE 20	<b>65ARi40</b> PAGE 19	<b>65ARi40MTL</b> PAGE 19	
100mm	100ARG20 PAGE 5	100ARi20 PAGE 5	100ARi20MTL PAGE 4	100ARiCO20 PAGE 4
	<b>100ARG30</b> PAGE 6		<b>100ARi40MTL</b> PAGE 4	



## TR Standard Range

65mm	65TRG25 PAGE 22	65TRi25 PAGE 22	65TRi25MTL PAGE 21	65TRiCO25 PAGE 21
	<b>65TRG40</b> PAGE 24	<b>65TRi40</b> PAGE 23	<b>65TRi40MTL</b> PAGE 23	
100mm	100TRG20 PAGE 8	100TRi20 PAGE 8	100TRi20MTL PAGE 7	100TRiCO20 PAGE 7
			<b>100TRi40MTL</b> PAGE 7	

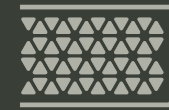

## MND Marc Newson Design

65mm	65MNDG25 PAGE 31	65MNDi25 PAGE 30	65MNDi25MTL PAGE 29	65MNDiCO25 PAGE 29
	65MNDGP25 PAGE 32	65MNDiP25 PAGE 31	65MNDiP25MTL PAGE 29	65MNDiCOP25 PAGE 30
100mm	100MNDG20 PAGE 13	100MNDi20 PAGE 12	100MNDi20MTL PAGE 11	100MNDiCO20 PAGE 11
			100MNDiP20MTL PAGE 11	100MNDiCOP20 PAGE 12



## PS Punched Slot

RANGE - WIDTH -	MODULAR KITS		MADE TO LENGTH - CUSTOM OUTLET -	FIXED-LENGTH - CENTRE OUTLET -
	uPVC Channel	Stainless Steel Channel	All Stainless Steel	All Stainless Steel
38mm	<b>38PSG40</b> PAGE 42		<b>38PSi40MTL</b> PAGE 42	
65mm	65PSG25 PAGE 34	65PSi25 PAGE 34	65PSi25MTL PAGE 33	65PSiCO25 PAGE 33
	<b>65PSG40</b> PAGE 36	<b>65PSi40</b> PAGE 35	<b>65PSi40MTL</b> PAGE 35	
100mm	100PSG20 PAGE 16	100PSi20 PAGE 16	100PSi20MTL PAGE 15	100PSiCO20 PAGE 15
			<b>100PSi40MTL</b> PAGE 15	

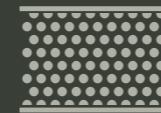

## PH Punched Hole

38mm	<b>38PHG40</b> PAGE 43		<b>38PHi40MTL</b> PAGE 43	
65mm	65PHG25 PAGE 38	65PHi25 PAGE 38	65PHi25MTL PAGE 37	65PHiCO25 PAGE 37
	<b>65PHG40</b> PAGE 40	<b>65PHi40</b> PAGE 39	<b>65PHi40MTL</b> PAGE 39	



## Ti Tile Insert

65mm	65TiG40 PAGE 26	65Tii40 PAGE 26	65Tii30MTL PAGE 25	65TiiCO30 PAGE 25
			65Tii40MTL PAGE 25	
			65Tii40-22MTL PAGE 25	
100mm			100Tii30MTL PAGE 9	100TiiCO30 PAGE 9
			100Tii40MTL PAGE 9	
			100Tii40-22MTL PAGE 9	



## TRTi Standard Range Tile Insert

65mm	65TRTiG25 PAGE 28	65TRTi25 PAGE 28	65TRTi25MTL PAGE 27	65TRTiCO25 PAGE 27
100mm			100TRTi25MTL PAGE 10	100TRTiCO25 PAGE 10

## Product Codes

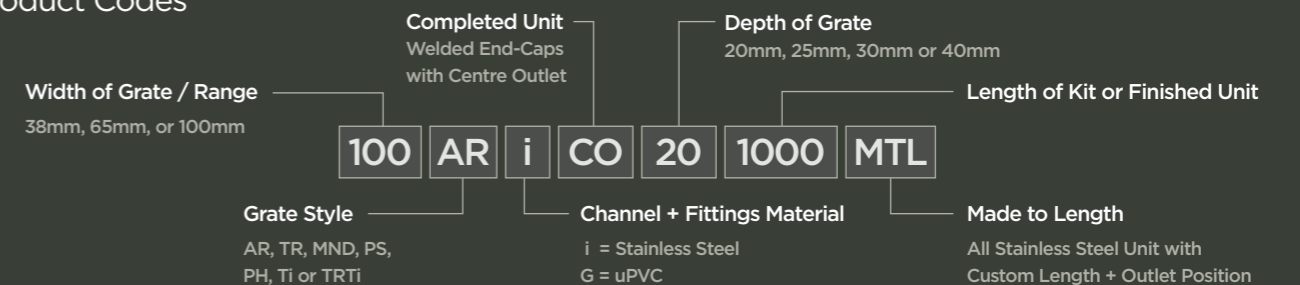

# 100 Range

## Available Grate Styles



AR



TR

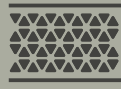

MND



PS



Ti



TRTi

**100AR**

The 100AR is the original premium architectural grate featuring a 2mm wire/2.5mm gap.

Manufactured from 316 marine grade stainless steel, the 100AR is 100mm wide and available in 20mm depth as Modular or Fixed-Length Units. Made-to-Length available in 20mm and 40mm depths.

316  
GRADE



## Made-to-Length

All stainless steel drainage unit made to specified length with specified outlet position.

**Outlet Suits Pipe:** DN40 / DN50 / DN65 / DN80 / DN100

PRODUCT	WIDTH x DEPTH
<b>100ARi20MTL</b>	109mm x 22mm
<b>100ARi40MTL</b>	109mm x 42mm

## Fixed-Length Centre Outlet Units

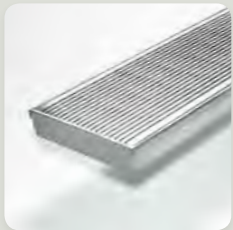

### 100ARiCO20

All Stainless Steel  
**Outlet Suits Pipe:** DN80

**FIXED-LENGTH UNIT**

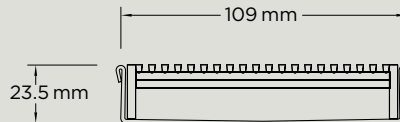

PRODUCT	LENGTH
<b>100ARiCO20-0900</b>	900mm
<b>100ARiCO20-1000</b>	1000mm

PRODUCT	LENGTH
<b>100ARiCO20-1200</b>	1200mm
<b>100ARiCO20-1500</b>	1500mm

## Modular Kits

Lengths over 3000mm available on request.

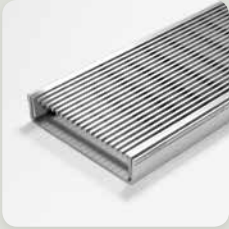

### 100ARi20

All Stainless Steel

Outlet Suits Pipe: DN50 / DN80

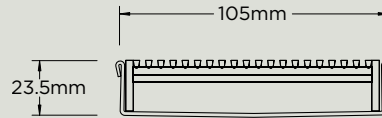

MODULAR KIT

PRODUCT	LENGTH - UP TO -
100ARi20-0900	900mm
100ARi20-1000	1000mm
100ARi20-1200	1200mm
100ARi20-1500	1500mm
100ARi20-1800	1800mm
100ARi20-1900	1900mm
100ARi20-2000	2000mm
100ARi20-2100	2100mm

PRODUCT	LENGTH - UP TO -
100ARi20-2200	2200mm
100ARi20-2400	2400mm
100ARi20-2500	2500mm
100ARi20-2700	2700mm
100ARi20-2800	2800mm
100ARi20-2900	2900mm
100ARi20-3000	3000mm

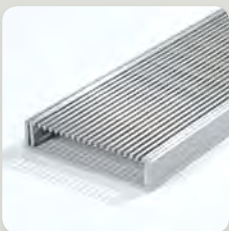

### 100ARG20

uPVC Channel + Fittings

Outlet Suits Pipe: DN40 / DN50 / DN80 / DN100

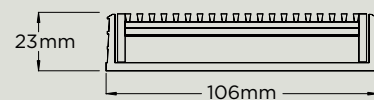

MODULAR KIT

PRODUCT	LENGTH - UP TO -
100ARG20-0900	900mm
100ARG20-1000	1000mm
100ARG20-1200	1200mm
100ARG20-1500	1500mm
100ARG20-1800	1800mm
100ARG20-1900	1900mm
100ARG20-2000	2000mm
100ARG20-2100	2100mm

PRODUCT	LENGTH - UP TO -
100ARG20-2200	2200mm
100ARG20-2400	2400mm
100ARG20-2500	2500mm
100ARG20-2700	2700mm
100ARG20-2800	2800mm
100ARG20-2900	2900mm
100ARG20-3000	3000mm

# 100 Range

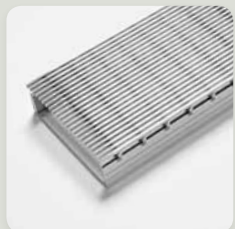

## 100ARG30

uPVC Channel + Fittings

Outlet Suits Pipe: DN40 / DN50 / DN80 / DN100

**MODULAR KIT**

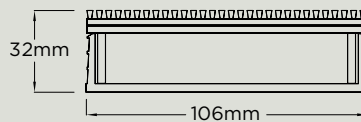

PRODUCT	LENGTH - UP TO -
100ARG30-0900	900mm
100ARG30-1000	1000mm
100ARG30-1200	1200mm
100ARG30-1500	1500mm
100ARG30-1800	1800mm
100ARG30-1900	1900mm
100ARG30-2000	2000mm
100ARG30-2100	2100mm

PRODUCT	LENGTH - UP TO -
100ARG30-2200	2200mm
100ARG30-2400	2400mm
100ARG30-2500	2500mm
100ARG30-2700	2700mm
100ARG30-2800	2800mm
100ARG30-2900	2900mm
100ARG30-3000	3000mm

# 100 Range



The 100TR is a standard style grate featuring a 3mm wire/5mm gap.

Manufactured from 316 marine grade stainless steel, the 100TR is 100mm wide and available in 20mm depth as Modular or Fixed-Length Units, and 40mm or 20mm as Made-to-Length.

NON FINISHED FINISH

316 GRADE



## Made-to-Length

All stainless steel drainage unit made to specified length with specified outlet position.

**Outlet Suits Pipe:** DN40 / DN50 / DN65 / DN80 / DN100

**Note:** 304 grade stainless steel available on application.

PRODUCT	WIDTH x DEPTH
<b>100TRi20MTL</b>	109mm x 22mm
<b>100TRi40MTL</b>	109mm x 42mm

## Fixed-Length Centre Outlet Units



### 100TRiCO20

All Stainless Steel

**Outlet Suits Pipe:** DN80

**FIXED-LENGTH UNIT**

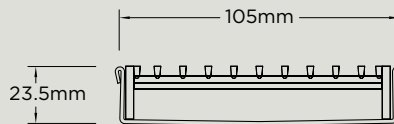

PRODUCT	LENGTH
<b>100TRiCO20-0900</b>	900mm
<b>100TRiCO20-1000</b>	1000mm

PRODUCT	LENGTH
<b>100TRiCO20-1200</b>	1200mm
<b>100TRiCO20-1500</b>	1500mm



# 100 Range

## Modular Kits

Lengths over 3000mm available on request.



### 100TRI20

All Stainless Steel

Outlet Suits Pipe: DN50 / DN80

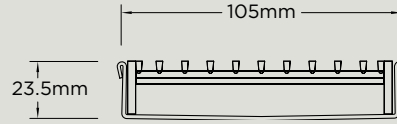

MODULAR KIT

PRODUCT	LENGTH - UP TO -
100TRI20-0900	900mm
100TRI20-1000	1000mm
100TRI20-1200	1200mm
100TRI20-1500	1500mm
100TRI20-1800	1800mm
100TRI20-1900	1900mm
100TRI20-2000	2000mm
100TRI20-2100	2100mm

PRODUCT	LENGTH - UP TO -
100TRI20-2200	2200mm
100TRI20-2400	2400mm
100TRI20-2500	2500mm
100TRI20-2700	2700mm
100TRI20-2800	2800mm
100TRI20-2900	2900mm
100TRI20-3000	3000mm



### 100TRG20

uPVC Channel + Fittings

Outlet Suits Pipe: DN40 / DN50 / DN80 / DN100

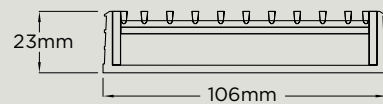

MODULAR KIT

PRODUCT	LENGTH - UP TO -
100TRG20-0900	900mm
100TRG20-1000	1000mm
100TRG20-1200	1200mm
100TRG20-1500	1500mm
100TRG20-1800	1800mm
100TRG20-1900	1900mm
100TRG20-2000	2000mm
100TRG20-2100	2100mm

PRODUCT	LENGTH - UP TO -
100TRG20-2200	2200mm
100TRG20-2400	2400mm
100TRG20-2500	2500mm
100TRG20-2700	2700mm
100TRG20-2800	2800mm
100TRG20-2900	2900mm
100TRG20-3000	3000mm

# 100 Range



## The 100Ti is a premium Tile Insert drain designed to blend seamlessly with tiled floors.

Our premium Tile Insert is manufactured from 3mm stainless steel.  
 The 100Ti30MTL and 100TiCO30 are suitable for tiles up to 12mm deep.  
 The 100Ti40MTL is suitable for tiles up to 16mm deep.  
 The 100Ti40-22MTL is suitable for tiles up to 20mm deep.



## Made-to-Length

All stainless steel drainage unit made to specified length with specified outlet position.

**Outlet Suits Pipe:** DN40 / DN50 / DN65 / DN80 / DN100

PRODUCT	WIDTH x DEPTH
<b>100Ti30MTL</b>	107mm x 33mm
<b>100Ti40MTL</b>	107mm x 42mm
<b>100Ti40-22MTL</b>	107mm x 42mm

## Fixed-Length Centre Outlet Units



### 100TiCO30

All Stainless Steel  
**Outlet Suits Pipe:** DN80

**FIXED-LENGTH UNIT**

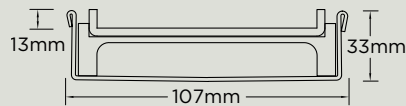

PRODUCT	LENGTH
<b>100TiCO30-0900</b>	900mm
<b>100TiCO30-1000</b>	1000mm

PRODUCT	LENGTH
<b>100TiCO30-1200</b>	1200mm

# 100 Range

**100TRTi**

The 100TRTi is a standard Tile Insert drain designed to blend seamlessly with tiled floors.

Our standard Tile Insert is made from 1.5mm stainless steel.

The TRTi is suitable for a tile up to 8mm deep.

**316**  
GRADE

## Made-to-Length

All stainless steel drainage unit made to specified length with specified outlet position.

**Outlet Suits Pipe:** DN40 / DN50 / DN65 / DN80 / DN100

**Note:** 304 grade stainless steel available on application.

**PRODUCT**

**WIDTH x DEPTH**

**100TRTi25MTL**

107mm x 27mm

## Fixed-Length Centre Outlet Units



**100TRTiCO25**

All Stainless Steel

**Outlet Suits Pipe:** DN80

**FIXED-LENGTH UNIT**

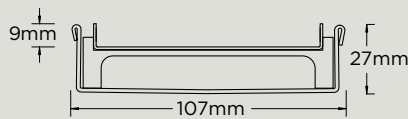

**PRODUCT**

**LENGTH**

**100TRTiCO25-0900**

900mm

**100TRTiCO25-1000**

1000mm

**PRODUCT**

**LENGTH**

**100TRTiCO25-1200**

1200mm



Our designer grate featuring a tessellated hexagonal design created in collaboration with Marc Newson.

Finishes: Stainless Steel, Black, White, Brass, Blue

5 FINISHES

316 GRADE

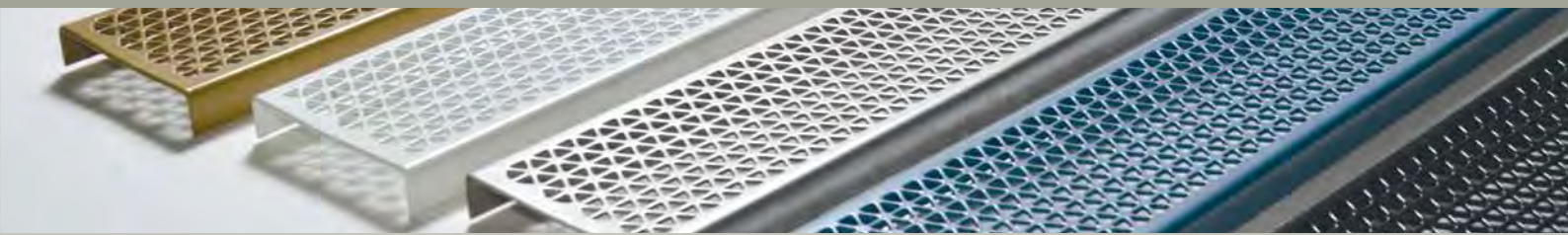
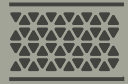

### Made-to-Length

All stainless steel unit made to specified length with specified outlet position.

**Outlet Suits Pipe:**

DN40 / DN50 / DN65 / DN80 / DN100

PRODUCT	COLOUR	WIDTH x DEPTH
100MNDi20MTL	Stainless Steel	109mm x 22mm
100MNDiP20MTL	Black, White, Blue or Brass	109mm x 22mm

### Fixed-Length Centre Outlet Units



#### 100MNDiCO20

All Stainless Steel

**Colour:** Stainless Steel

**Outlet Suits Pipe:** DN80

**FIXED-LENGTH UNIT**

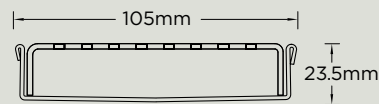

PRODUCT	LENGTH
100MNDiCO20-0900	900mm
100MNDiCO20-1000	1000mm

PRODUCT	LENGTH
100MNDiCO20-1200	1200mm
100MNDiCO20-1500	1500mm

# 100 Range

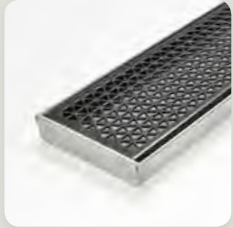

## 100MNDiCOP20

All Stainless Steel

Colour: Black / White / Blue / Brass

Outlet Suits Pipe: DN80

**FIXED-LENGTH UNIT**

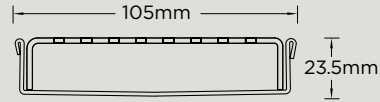

PLEASE SPECIFY COLOUR WITH ORDER

PRODUCT	LENGTH
100MNDiCOP20-0900	900mm
100MNDiCOP20-1000	1000mm

PRODUCT	LENGTH
100MNDiCOP20-1200	1200mm
100MNDiCOP20-1500	1500mm

## Modular Kits

Lengths over 3000mm available on request.

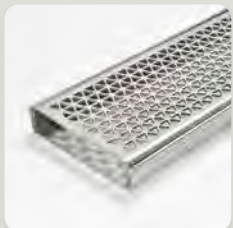

## 100MNDi20

All Stainless Steel

Colour: Stainless Steel

Outlet Suits Pipe: DN50 / DN80

**MODULAR KIT**

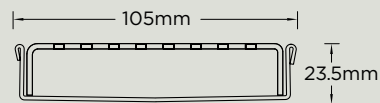

PRODUCT	LENGTH - UP TO -
100MNDi20-0900	900mm
100MNDi20-1000	1000mm
100MNDi20-1200	1200mm
100MNDi20-1500	1500mm
100MNDi20-1800	1800mm
100MNDi20-1900	1900mm
100MNDi20-2000	2000mm
100MNDi20-2100	2100mm

PRODUCT	LENGTH - UP TO -
100MNDi20-2200	2200mm
100MNDi20-2400	2400mm
100MNDi20-2500	2500mm
100MNDi20-2700	2700mm
100MNDi20-2800	2800mm
100MNDi20-2900	2900mm
100MNDi20-3000	3000mm

# 100 Range



## 100MNDG20

uPVC Channel + Fittings

Colour: Stainless Steel

Outlet Suits Pipe: DN40 / DN50 / DN80 / DN100

MODULAR KIT

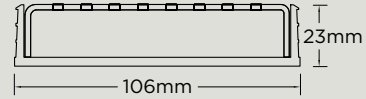

PRODUCT	LENGTH - UP TO -
100MNDG20-0900	900mm
100MNDG20-1000	1000mm
100MNDG20-1200	1200mm
100MNDG20-1500	1500mm
100MNDG20-1800	1800mm
100MNDG20-1900	1900mm
100MNDG20-2000	2000mm
100MNDG20-2100	2100mm

PRODUCT	LENGTH - UP TO -
100MNDG20-2200	2200mm
100MNDG20-2400	2400mm
100MNDG20-2500	2500mm
100MNDG20-2700	2700mm
100MNDG20-2800	2800mm
100MNDG20-2900	2900mm
100MNDG20-3000	3000mm



## 100MNDiP20

All Stainless Steel

Colour: Black / White / Blue / Brass

Outlet Suits Pipe: DN50 / DN80

MODULAR KIT

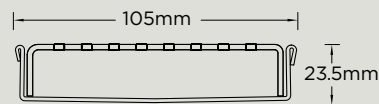

PLEASE SPECIFY COLOUR WITH ORDER

PRODUCT	LENGTH - UP TO -
100MNDiP20-0900	900mm
100MNDiP20-1000	1000mm
100MNDiP20-1200	1200mm
100MNDiP20-1500	1500mm
100MNDiP20-1800	1800mm
100MNDiP20-1900	1900mm
100MNDiP20-2000	2000mm
100MNDiP20-2100	2100mm

PRODUCT	LENGTH - UP TO -
100MNDiP20-2200	2200mm
100MNDiP20-2400	2400mm
100MNDiP20-2500	2500mm
100MNDiP20-2700	2700mm
100MNDiP20-2800	2800mm
100MNDiP20-2900	2900mm
100MNDiP20-3000	3000mm

# 100 Range

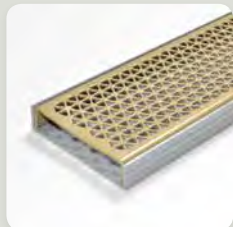

## 100MNDGP20

uPVC Channel + Fittings

**Colour:** Black / White / Blue / Brass

**Outlet Suits Pipe:** DN40 / DN50 / DN80 / DN100

MODULAR KIT

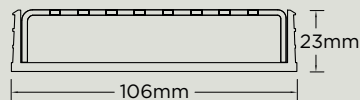

PLEASE  
SPECIFY  
COLOUR  
WITH  
ORDER

PRODUCT	LENGTH - UP TO -
100MNDGP20-0900	900mm
100MNDGP20-1000	1000mm
100MNDGP20-1200	1200mm
100MNDGP20-1500	1500mm
100MNDGP20-1800	1800mm
100MNDGP20-1900	1900mm
100MNDGP20-2000	2000mm
100MNDGP20-2100	2100mm

PRODUCT	LENGTH - UP TO -
100MNDGP20-2200	2200mm
100MNDGP20-2400	2400mm
100MNDGP20-2500	2500mm
100MNDGP20-2700	2700mm
100MNDGP20-2800	2800mm
100MNDGP20-2900	2900mm
100MNDGP20-3000	3000mm



## The 100PS is a Punched Slot grate design.

Manufactured from 316 marine grade stainless steel, the 100PS is 100mm wide and available in 20mm depth as Modular Kits or Fixed-Length Units, and 40mm and 20mm as Made-to-Length.



## Made-to-Length

All stainless steel drainage unit made to specified length with specified outlet position.

**Outlet Suits Pipe:** DN40 / DN50 / DN65 / DN80 / DN100

PRODUCT	WIDTH x DEPTH
<b>100PSi20MTL</b>	109mm x 22mm
<b>100PSi40MTL</b>	109mm x 42mm

## Fixed-Length Centre Outlet Units



### 100PSiCO20

All Stainless Steel  
**Outlet Suits Pipe:** DN80

**FIXED-LENGTH UNIT**

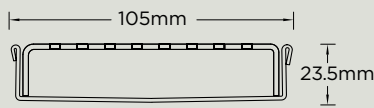

PRODUCT	LENGTH
<b>100PSiCO20-0900</b>	900mm
<b>100PSiCO20-1000</b>	1000mm

PRODUCT	LENGTH
<b>100PSiCO20-1200</b>	1200mm
<b>100PSiCO20-1500</b>	1500mm



# 100 Range

## Modular Kits

Lengths over 3000mm available on request.



### 100PSi20

All Stainless Steel

Outlet Suits Pipe: DN50 / DN80

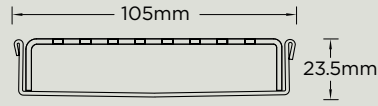

MODULAR KIT

PRODUCT	LENGTH - UP TO -
100PSi20-0900	900mm
100PSi20-1000	1000mm
100PSi20-1200	1200mm
100PSi20-1500	1500mm
100PSi20-1800	1800mm
100PSi20-1900	1900mm
100PSi20-2000	2000mm
100PSi20-2100	2100mm

PRODUCT	LENGTH - UP TO -
100PSi20-2200	2200mm
100PSi20-2400	2400mm
100PSi20-2500	2500mm
100PSi20-2700	2700mm
100PSi20-2800	2800mm
100PSi20-2900	2900mm
100PSi20-3000	3000mm



### 100PSG20

uPVC Channel + Fittings

Outlet Suits Pipe: DN40 / DN50 / DN80 / DN100

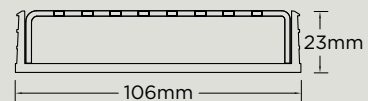

MODULAR KIT

PRODUCT	LENGTH - UP TO -
100PSG20-0900	900mm
100PSG20-1000	1000mm
100PSG20-1200	1200mm
100PSG20-1500	1500mm
100PSG20-1800	1800mm
100PSG20-1900	1900mm
100PSG20-2000	2000mm
100PSG20-2100	2100mm

PRODUCT	LENGTH - UP TO -
100PSG20-2200	2200mm
100PSG20-2400	2400mm
100PSG20-2500	2500mm
100PSG20-2700	2700mm
100PSG20-2800	2800mm
100PSG20-2900	2900mm
100PSG20-3000	3000mm

# 65 Range

## Available Grate Styles



The 65AR25 is our original premium architectural grate and features a 2mm wire/2.5mm gap.

Manufactured from 316 marine grade the 65AR25 is 65mm wide and 25mm deep.

316  
GRADE



## Made-to-Length

All stainless steel drainage unit made to specified length with specified outlet position.

**Outlet Suits Pipe:** DN40 / DN50 / DN65

PRODUCT	WIDTH x DEPTH
65ARi25MTL	74mm x 27mm

## Fixed-Length Centre Outlet Units



### 65ARiCO25

All Stainless Steel  
**Outlet Suits Pipe:** DN50

**FIXED-LENGTH UNIT**

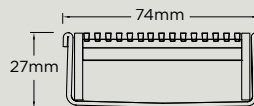

PRODUCT	LENGTH
65ARiCO25-0900	900mm
65ARiCO25-1000	1000mm

PRODUCT	LENGTH
65ARiCO25-1200	1200mm
65ARiCO25-1500	1500mm

# 65 Range

## Modular Kits

Lengths over 3000mm available on request.



### 65ARi25

All Stainless Steel  
Outlet Suits Pipe: DN50

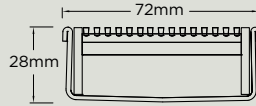

MODULAR KIT

PRODUCT	LENGTH - UP TO -
65ARi25-0750	750mm
65ARi25-0900	900mm
65ARi25-1000	1000mm
65ARi25-1200	1200mm
65ARi25-1500	1500mm
65ARi25-1800	1800mm
65ARi25-1900	1900mm
65ARi25-2000	2000mm

PRODUCT	LENGTH - UP TO -
65ARi25-2100	2100mm
65ARi25-2200	2200mm
65ARi25-2400	2400mm
65ARi25-2500	2500mm
65ARi25-2700	2700mm
65ARi25-2800	2800mm
65ARi25-2900	2900mm
65ARi25-3000	3000mm



### 65ARG25

uPVC Channel + Fittings  
Outlet Suits Pipe: DN40 / DN50

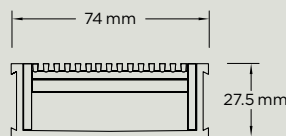

MODULAR KIT

PRODUCT	LENGTH - UP TO -
65ARG25-0750	750mm
65ARG25-0900	900mm
65ARG25-1000	1000mm
65ARG25-1200	1200mm
65ARG25-1500	1500mm
65ARG25-1800	1800mm
65ARG25-1900	1900mm
65ARG25-2000	2000mm

PRODUCT	LENGTH - UP TO -
65ARG25-2100	2100mm
65ARG25-2200	2200mm
65ARG25-2400	2400mm
65ARG25-2500	2500mm
65ARG25-2700	2700mm
65ARG25-2800	2800mm
65ARG25-2900	2900mm
65ARG25-3000	3000mm

## 65AR40

The 65AR40 is our original premium style architectural grate design and features a 2mm wire/2.5mm gap.

Manufactured from 316 marine grade the 65AR40 is 65mm wide and 40mm deep.

316  
GRADE



## Made-to-Length

All stainless steel drainage unit made to specified length with specified outlet position.

**Outlet Suits Pipe:** DN40 / DN50 / DN65

### PRODUCT

### WIDTH x DEPTH

65ARi40MTL

74mm x 42mm

## Modular Kits

Lengths over 3000mm available on request.



## 65ARi40

All Stainless Steel

**Outlet Suits Pipe:** DN50

MODULAR KIT

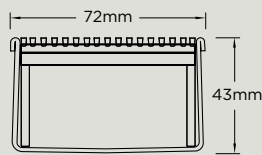

PRODUCT	LENGTH - UP TO -
65ARi40-0900	900mm
65ARi40-1000	1000mm
65ARi40-1200	1200mm
65ARi40-1500	1500mm
65ARi40-1800	1800mm
65ARi40-1900	1900mm
65ARi40-2000	2000mm
65ARi40-2100	2100mm

PRODUCT	LENGTH - UP TO -
65ARi40-2200	2200mm
65ARi40-2400	2400mm
65ARi40-2500	2500mm
65ARi40-2700	2700mm
65ARi40-2800	2800mm
65ARi40-2900	2900mm
65ARi40-3000	3000mm

# 65 Range



## 65ARG40

uPVC Channel + Fittings

Outlet Suits Pipe: DN40 / DN50

MODULAR KIT

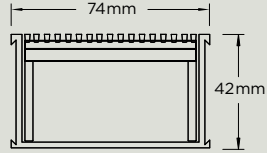

PRODUCT	LENGTH - UP TO -
<b>65ARG40-0900</b>	900mm
<b>65ARG40-1000</b>	1000mm
<b>65ARG40-1200</b>	1200mm
<b>65ARG40-1500</b>	1500mm
<b>65ARG40-1800</b>	1800mm
<b>65ARG40-1900</b>	1900mm
<b>65ARG40-2000</b>	2000mm
<b>65ARG40-2100</b>	2100mm

PRODUCT	LENGTH - UP TO -
<b>65ARG40-2200</b>	2200mm
<b>65ARG40-2400</b>	2400mm
<b>65ARG40-2500</b>	2500mm
<b>65ARG40-2700</b>	2700mm
<b>65ARG40-2800</b>	2800mm
<b>65ARG40-2900</b>	2900mm
<b>65ARG40-3000</b>	3000mm

# 65 Range

## Available Grate Styles



AR



TR



Ti



TRTi

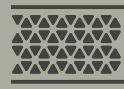

MND



PS

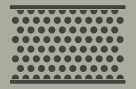

PH

**65TR25**

The 65TR25 is a standard grate design featuring a 3mm wire/5mm gap.

Manufactured from 316 marine grade the 65TR25 is 65mm wide and 25mm deep.

NON FINISHED FINISH

316 GRADE



## Made-to-Length

All stainless steel drainage unit made to specified length with specified outlet position.

**Outlet Suits Pipe:** DN40 / DN50 / DN65

**Note:** 304 grade stainless steel available on application.

PRODUCT

WIDTH x DEPTH

65TRi25MTL

74mm x 27mm

## Fixed-Length Centre Outlet Units



### 65TRiCO25

All Stainless Steel

**Outlet Suits Pipe:** DN50

FIXED-LENGTH UNIT

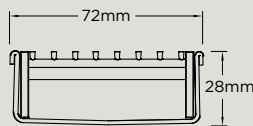

PRODUCT

LENGTH

65TRiCO25-0900

900mm

65TRiCO25-1000

1000mm

PRODUCT

LENGTH

65TRiCO25-1200

1200mm

65TRiCO25-1500

1500mm

# 65 Range

## Modular Kits

Lengths over 3000mm available on request.



### 65TRi25

All Stainless Steel

Outlet Suits Pipe: DN50

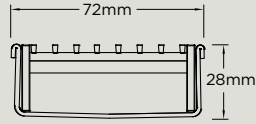

MODULAR KIT

PRODUCT	LENGTH - UP TO -
65TRi25-0900	900mm
65TRi25-1000	1000mm
65TRi25-1200	1200mm
65TRi25-1500	1500mm
65TRi25-1800	1800mm
65TRi25-1900	1900mm
65TRi25-2000	2000mm
65TRi25-2100	2100mm

PRODUCT	LENGTH - UP TO -
65TRi25-2200	2200mm
65TRi25-2400	2400mm
65TRi25-2500	2500mm
65TRi25-2700	2700mm
65TRi25-2800	2800mm
65TRi25-2900	2900mm
65TRi25-3000	3000mm

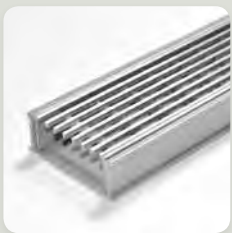

### 65TRG25

uPVC Channel + Fittings

Outlet Suits Pipe: DN40 / DN50

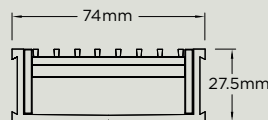

MODULAR KIT

PRODUCT	LENGTH - UP TO -
65TRG25-0900	900mm
65TRG25-1000	1000mm
65TRG25-1200	1200mm
65TRG25-1500	1500mm
65TRG25-1800	1800mm
65TRG25-1900	1900mm
65TRG25-2000	2000mm
65TRG25-2100	2100mm

PRODUCT	LENGTH - UP TO -
65TRG25-2200	2200mm
65TRG25-2400	2400mm
65TRG25-2500	2500mm
65TRG25-2700	2700mm
65TRG25-2800	2800mm
65TRG25-2900	2900mm
65TRG25-3000	3000mm



The 65TR40 is a standard style grate featuring a 3mm wire/5mm gap.

Manufactured from 316 marine grade the 65TR40 is 65mm wide and 40mm deep.

NON FINISHED FINISH

316 GRADE



## Made-to-Length

All stainless steel drainage unit made to specified length with specified outlet position.

Outlet Suits Pipe: DN40 / DN50 / DN65

PRODUCT	WIDTH x DEPTH
65TRi40MTL	74mm x 42mm

## Modular Kits

Lengths over 3000mm available on request.



### 65TRi40

All Stainless Steel  
Outlet Suits Pipe: DN50

MODULAR KIT

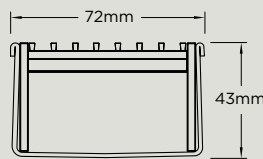

PRODUCT	LENGTH - UP TO -
65TRi40-0900	900mm
65TRi40-1000	1000mm
65TRi40-1200	1200mm
65TRi40-1500	1500mm
65TRi40-1800	1800mm
65TRi40-1900	1900mm
65TRi40-2000	2000mm
65TRi40-2100	2100mm

PRODUCT	LENGTH - UP TO -
65TRi40-2200	2200mm
65TRi40-2400	2400mm
65TRi40-2500	2500mm
65TRi40-2700	2700mm
65TRi40-2800	2800mm
65TRi40-2900	2900mm
65TRi40-3000	3000mm



# 65 Range



## 65TRG40

uPVC Channel + Fittings

Outlet Suits Pipe: DN40 / DN50

MODULAR KIT

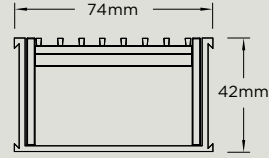

PRODUCT	LENGTH - UP TO -
<b>65TRG40-0900</b>	900mm
<b>65TRG40-1000</b>	1000mm
<b>65TRG40-1200</b>	1200mm
<b>65TRG40-1500</b>	1500mm
<b>65TRG40-1800</b>	1800mm
<b>65TRG40-1900</b>	1900mm
<b>65TRG40-2000</b>	2000mm
<b>65TRG40-2100</b>	2100mm

PRODUCT	LENGTH - UP TO -
<b>65TRG40-2200</b>	2200mm
<b>65TRG40-2400</b>	2400mm
<b>65TRG40-2500</b>	2500mm
<b>65TRG40-2700</b>	2700mm
<b>65TRG40-2800</b>	2800mm
<b>65TRG40-2900</b>	2900mm
<b>65TRG40-3000</b>	3000mm



The 65Ti is a premium tile insert drain that has been designed to blend in with a finished floor.

65Tii30MTL / 65TiiCO30 Suits tiles up to 12mm thick.

65Tii40MTL Suits tiles up to 16mm thick.

65Tii40 / 65TiG40 / 65Tii40-22MTL Suits tiles up to 20mm thick.



## Made-to-Length

All stainless steel drainage unit made to specified length with specified outlet position.

**Outlet Suits Pipe:** DN40 / DN50 / DN65

PRODUCT	WIDTH x DEPTH
<b>65Tii30MTL</b>	74mm x 33mm
<b>65Tii40MTL</b>	74mm x 42mm
<b>65Tii40-22MTL</b>	74mm x 42mm

## Fixed-Length Centre Outlet Units

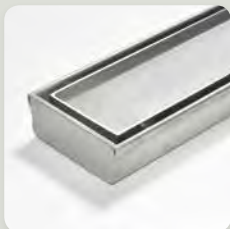

### 65TiiCO30

All Stainless Steel  
**Outlet Suits Pipe:** DN50

**FIXED-LENGTH UNIT**

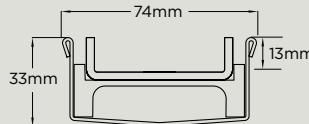

PRODUCT	LENGTH
<b>65TiiCO30-0900</b>	900mm
<b>65TiiCO30-1000</b>	1000mm

PRODUCT	LENGTH
<b>65TiiCO30-1200</b>	1200mm

# 65 Range

## Modular Kits

Lengths over 3000mm available on request.



### 65Tii40

All Stainless Steel  
Outlet Suits Pipe: DN50

MODULAR KIT

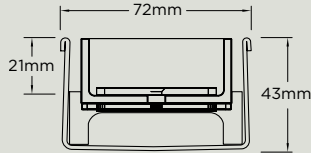

PRODUCT	LENGTH - UP TO -
65Tii40-1000	1000mm
65Tii40-1200	1200mm
65Tii40-2000	2000mm

PRODUCT	LENGTH - UP TO -
65Tii40-2200	2200mm
65Tii40-2400	2400mm
65Tii40-3000	3000mm



### 65TiG40

uPVC Channel + Fittings  
Outlet Suits Pipe: DN40 / DN50

MODULAR KIT

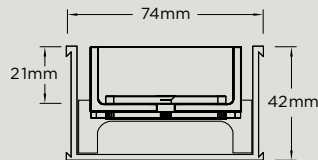

PRODUCT	LENGTH - UP TO -
65TiG40-1000	1000mm
65TiG40-1200	1200mm
65TiG40-2000	2000mm

PRODUCT	LENGTH - UP TO -
65TiG40-2200	2200mm
65TiG40-2400	2400mm
65TiG40-3000	3000mm



The 65TRTi is a standard Tile Insert drain designed to blend in with a tiled floor.

The standard tile insert is made from 1.5mm thick sheet. The 65TRTi series is suitable for up to a 8mm thick tile.



## Made-to-Length

All stainless steel drainage unit made to specified length with specified outlet position.

**Outlet Suits Pipe:** DN40 / DN50 / DN65

**Note:** 304 grade stainless steel available on application.

PRODUCT	WIDTH x DEPTH
65TRTi25MTL	74mm x 27mm

## Fixed-Length Centre Outlet Units

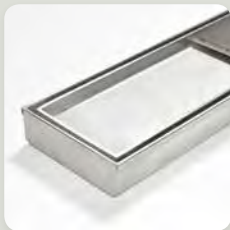

### 65TRTiCO25

All Stainless Steel

**Outlet Suits Pipe:** DN50

**FIXED-LENGTH UNIT**

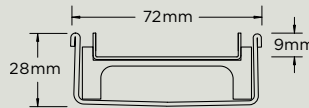

PRODUCT	LENGTH
65TRTiCO25-0900	900mm
65TRTiCO25-1000	1000mm

PRODUCT	LENGTH
65TRTiCO25-1200	1200mm

# 65 Range

## Modular Kits

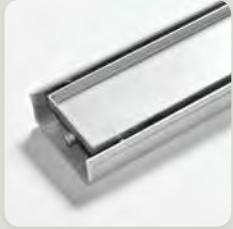

### 65TRTi25

All Stainless Steel  
Outlet Suits Pipe: DN50

**MODULAR KIT**

Kit length non-adjustable

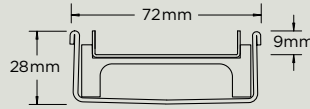

PRODUCT	LENGTH
<b>65TRTi25-0900</b>	900mm
<b>65TRTi25-1000</b>	1000mm

PRODUCT	LENGTH
<b>65TRTi25-1200</b>	1200mm



### 65TRTiG25

uPVC Channel + Fittings  
Outlet Suits Pipe: DN40 / DN50

**MODULAR KIT**

Kit length non-adjustable

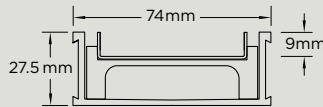

PRODUCT	LENGTH
<b>65TRTiG25-0900</b>	900mm
<b>65TRTiG25-1000</b>	1000mm

PRODUCT	LENGTH
<b>65TRTiG25-1200</b>	1200mm



Our designer grate featuring a tessellated hexagonal design created by Marc Newson.

Manufactured from 316 marine grade stainless steel. 65mm wide and 25mm deep as Made-to-Length, Modular Kits and Fixed-Length Units. Finishes: Stainless Steel, Black, White, Brass, Blue

5 FINISHES

316 GRADE

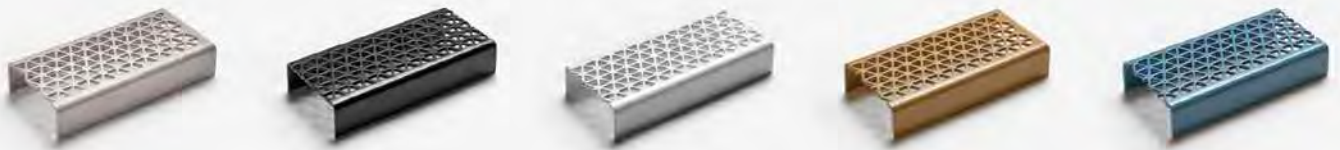
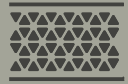

### Made-to-Length

All stainless steel drainage unit made to specified length with specified outlet position.

Outlet Suits Pipe: DN40 / DN50 / DN65

PRODUCT	COLOUR	WIDTH x DEPTH
65MNDi25MTL	Stainless Steel	74mm x 27mm
65MNDiP25MTL	Black, White, Blue or Brass	74mm x 27mm

### Fixed-Length Centre Outlet Units



#### 65MNDiCO25

All Stainless Steel  
**Colour:** Stainless Steel  
**Outlet Suits Pipe:** DN50

**FIXED-LENGTH UNIT**

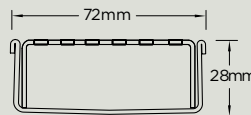

PRODUCT	LENGTH
65MNDiCO25-0900	900mm
65MNDiCO25-1000	1000mm

PRODUCT	LENGTH
65MNDiCO25-1200	1200mm
65MNDiCO25-1500	1500mm

# 65 Range

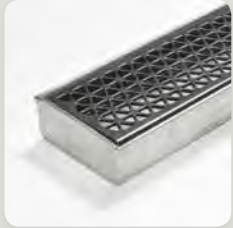

## 65MNDiCOP25

All Stainless Steel

Colour: Black / White / Blue / Brass

Outlet Suits Pipe: DN50

**FIXED-LENGTH UNIT**

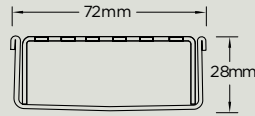

PLEASE SPECIFY COLOUR WITH ORDER

PRODUCT	LENGTH
65MNDiCOP25-0900	900mm
65MNDiCOP25-1000	1000mm

PRODUCT	LENGTH
65MNDiCOP25-1200	1200mm
65MNDiCOP25-1500	1500mm

## Modular Kits

Lengths over 3000mm available on request.



## 65MNDi25

All Stainless Steel

Colour: Stainless Steel

Outlet Suits Pipe: DN50

**MODULAR KIT**

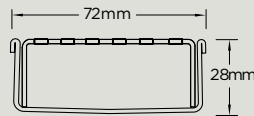

PRODUCT	LENGTH - UP TO -
65MNDi25-0900	900mm
65MNDi25-1000	1000mm
65MNDi25-1200	1200mm
65MNDi25-1500	1500mm
65MNDi25-1800	1800mm
65MNDi25-1900	1900mm
65MNDi25-2000	2000mm
65MNDi25-2100	2100mm

PRODUCT	LENGTH - UP TO -
65MNDi25-2200	2200mm
65MNDi25-2400	2400mm
65MNDi25-2500	2500mm
65MNDi25-2700	2700mm
65MNDi25-2800	2800mm
65MNDi25-2900	2900mm
65MNDi25-3000	3000mm



## 65MNDG25

uPVC Channel + Fittings  
**Colour:** Stainless Steel  
**Outlet Suits Pipe:** DN40 / DN50

**MODULAR KIT**

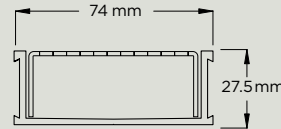

PRODUCT	LENGTH - UP TO -
65MNDG25-0900	900mm
65MNDG25-1000	1000mm
65MNDG25-1200	1200mm
65MNDG25-1500	1500mm
65MNDG25-1800	1800mm
65MNDG25-1900	1900mm
65MNDG25-2000	2000mm
65MNDG25-2100	2100mm

PRODUCT	LENGTH - UP TO -
65MNDG25-2200	2200mm
65MNDG25-2400	2400mm
65MNDG25-2500	2500mm
65MNDG25-2700	2700mm
65MNDG25-2800	2800mm
65MNDG25-2900	2900mm
65MNDG25-3000	3000mm



## 65MNDiP25

All Stainless Steel  
**Colour:** Black / White / Blue / Brass  
**Outlet Suits Pipe:** DN50

**MODULAR KIT**

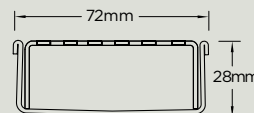

PLEASE  
SPECIFY  
COLOUR  
WITH  
ORDER

PRODUCT	LENGTH - UP TO -
65MNDiP25-0900	900mm
65MNDiP25-1000	1000mm
65MNDiP25-1200	1200mm
65MNDiP25-1500	1500mm
65MNDiP25-1800	1800mm
65MNDiP25-1900	1900mm
65MNDiP25-2000	2000mm
65MNDiP25-2100	2100mm

PRODUCT	LENGTH - UP TO -
65MNDiP25-2200	2200mm
65MNDiP25-2400	2400mm
65MNDiP25-2500	2500mm
65MNDiP25-2700	2700mm
65MNDiP25-2800	2800mm
65MNDiP25-2900	2900mm
65MNDiP25-3000	3000mm



# 65 Range

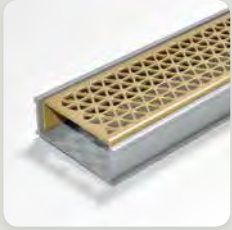

## 65MNDGP25

uPVC Channel + Fittings

**Colour:** Black / White / Blue / Brass

**Outlet Suits Pipe:** DN40 / DN50

MODULAR KIT

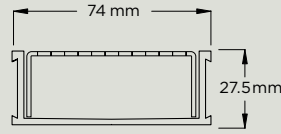

PLEASE  
SPECIFY  
COLOUR  
WITH  
ORDER

PRODUCT	LENGTH - UP TO -
65MNDGP25-0900	900mm
65MNDGP25-1000	1000mm
65MNDGP25-1200	1200mm
65MNDGP25-1500	1500mm
65MNDGP25-1800	1800mm
65MNDGP25-1900	1900mm
65MNDGP25-2000	2000mm
65MNDGP25-2100	2100mm

PRODUCT	LENGTH - UP TO -
65MNDGP25-2200	2200mm
65MNDGP25-2400	2400mm
65MNDGP25-2500	2500mm
65MNDGP25-2700	2700mm
65MNDGP25-2800	2800mm
65MNDGP25-2900	2900mm
65MNDGP25-3000	3000mm



## The 65PS25 is a Punched Slot grate design.

Manufactured from 316 marine grade the 65PS25 is 65mm wide and 25mm deep.



### Made-to-Length

All stainless steel drainage unit made to specified length with specified outlet position.

**Outlet Suits Pipe:** DN40 / DN50 / DN65

PRODUCT	WIDTH x DEPTH
<b>65PSi25MTL</b>	74mm x 27mm

### Fixed-Length Centre Outlet Units



## 65PSiCO25

All Stainless Steel  
**Outlet Suits Pipe:** DN50

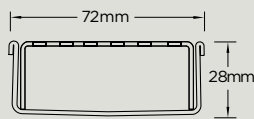

**FIXED-LENGTH UNIT**

PRODUCT	LENGTH
<b>65PSiCO25-0900</b>	900mm
<b>65PSiCO25-1000</b>	1000mm

PRODUCT	LENGTH
<b>65PSiCO25-1200</b>	1200mm
<b>65PSiCO25-1500</b>	1500mm

# 65 Range

## Modular Kits

Lengths over 3000mm available on request.



### 65PSi25

All Stainless Steel  
Outlet Suits Pipe: DN50

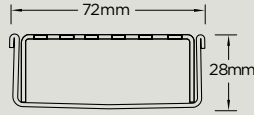

MODULAR KIT

PRODUCT	LENGTH - UP TO -
65PSi25-0900	900mm
65PSi25-1000	1000mm
65PSi25-1200	1200mm
65PSi25-1500	1500mm
65PSi25-1800	1800mm
65PSi25-1900	1900mm
65PSi25-2000	2000mm
65PSi25-2100	2100mm

PRODUCT	LENGTH - UP TO -
65PSi25-2200	2200mm
65PSi25-2400	2400mm
65PSi25-2500	2500mm
65PSi25-2700	2700mm
65PSi25-2800	2800mm
65PSi25-2900	2900mm
65PSi25-3000	3000mm



### 65PSG25

uPVC Channel + Fittings  
Outlet Suits Pipe: DN40 / DN50

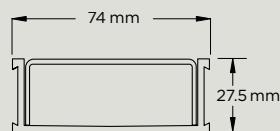

MODULAR KIT

PRODUCT	LENGTH - UP TO -
65PSG25-0900	900mm
65PSG25-1000	1000mm
65PSG25-1200	1200mm
65PSG25-1500	1500mm
65PSG25-1800	1800mm
65PSG25-1900	1900mm
65PSG25-2000	2000mm
65PSG25-2100	2100mm

PRODUCT	LENGTH - UP TO -
65PSG25-2200	2200mm
65PSG25-2400	2400mm
65PSG25-2500	2500mm
65PSG25-2700	2700mm
65PSG25-2800	2800mm
65PSG25-2900	2900mm
65PSG25-3000	3000mm



## The 65PS40 is a Punched Slot grate design.

Manufactured from 316 marine grade the 65PS40 is 65mm wide and 40mm deep.



## Made-to-Length

All stainless steel drainage unit made to specified length with specified outlet position.

**Outlet Suits Pipe:** DN40 / DN50 / DN65

PRODUCT	WIDTH x DEPTH
<b>65PSi40MTL</b>	74mm x 42mm

## Modular Kits

Lengths over 3000mm available on request.



### 65PSi40

All Stainless Steel  
**Outlet Suits Pipe:** DN50

**MODULAR KIT**

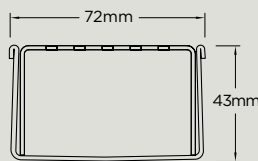

PRODUCT	LENGTH - UP TO -
<b>65PSi40-0900</b>	900mm
<b>65PSi40-1000</b>	1000mm
<b>65PSi40-1200</b>	1200mm
<b>65PSi40-1500</b>	1500mm
<b>65PSi40-1800</b>	1800mm
<b>65PSi40-1900</b>	1900mm
<b>65PSi40-2000</b>	2000mm
<b>65PSi40-2100</b>	2100mm

PRODUCT	LENGTH - UP TO -
<b>65PSi40-2200</b>	2200mm
<b>65PSi40-2400</b>	2400mm
<b>65PSi40-2500</b>	2500mm
<b>65PSi40-2700</b>	2700mm
<b>65PSi40-2800</b>	2800mm
<b>65PSi40-2900</b>	2900mm
<b>65PSi40-3000</b>	3000mm

# 65 Range

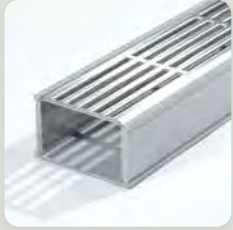

## 65PSG40

uPVC Channel + Fittings

Outlet Suits Pipe: DN40 / DN50

MODULAR KIT

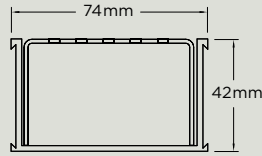

PRODUCT	LENGTH - UP TO -
<b>65PSG40-0900</b>	900mm
<b>65PSG40-1000</b>	1000mm
<b>65PSG40-1200</b>	1200mm
<b>65PSG40-1500</b>	1500mm
<b>65PSG40-1800</b>	1800mm
<b>65PSG40-1900</b>	1900mm
<b>65PSG40-2000</b>	2000mm
<b>65PSG40-2100</b>	2100mm

PRODUCT	LENGTH - UP TO -
<b>65PSG40-2200</b>	2200mm
<b>65PSG40-2400</b>	2400mm
<b>65PSG40-2500</b>	2500mm
<b>65PSG40-2700</b>	2700mm
<b>65PSG40-2800</b>	2800mm
<b>65PSG40-2900</b>	2900mm
<b>65PSG40-3000</b>	3000mm

**65PH25**

## The 65PH25 is a Punched Hole grate design.

Manufactured from 316 marine grade the 65PH25 is 65mm wide and 25mm deep.

**316  
GRADE**

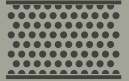

## Made-to-Length

All stainless steel drainage unit made to specified length with specified outlet position.

**Outlet Suits Pipe:** DN40 / DN50 / DN65

**PRODUCT**

**WIDTH x DEPTH**

**65PHi25MTL**

74mm x 27mm

## Fixed-Length Centre Outlet Units



### 65PHiCO25

All Stainless Steel  
**Outlet Suits Pipe:** DN50

**FIXED-LENGTH UNIT**

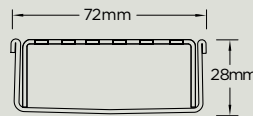

**PRODUCT**

**LENGTH**

**65PHiCO25-0900**

900mm

**65PHiCO25-1000**

1000mm

**PRODUCT**

**LENGTH**

**65PHiCO25-1200**

1200mm

**65PHiCO25-1500**

1500mm

# 65 Range

## Modular Kits

Lengths over 3000mm available on request.



### 65PHi25

All Stainless Steel

Outlet Suits Pipe: DN50

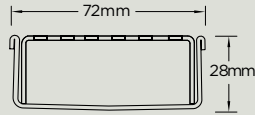

MODULAR KIT

PRODUCT	LENGTH - UP TO -
65PHi25-0900	900mm
65PHi25-1000	1000mm
65PHi25-1200	1200mm
65PHi25-1500	1500mm
65PHi25-1800	1800mm
65PHi25-1900	1900mm
65PHi25-2000	2000mm
65PHi25-2100	2100mm

PRODUCT	LENGTH - UP TO -
65PHi25-2200	2200mm
65PHi25-2400	2400mm
65PHi25-2500	2500mm
65PHi25-2700	2700mm
65PHi25-2800	2800mm
65PHi25-2900	2900mm
65PHi25-3000	3000mm

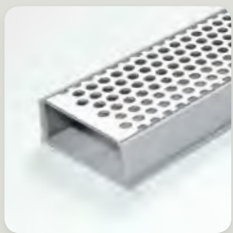

### 65PHG25

uPVC Channel + Fittings

Outlet Suits Pipe: DN40 / DN50

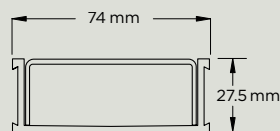

MODULAR KIT

PRODUCT	LENGTH - UP TO -
65PHG25-0900	900mm
65PHG25-1000	1000mm
65PHG25-1200	1200mm
65PHG25-1500	1500mm
65PHG25-1800	1800mm
65PHG25-1900	1900mm
65PHG25-2000	2000mm
65PHG25-2100	2100mm

PRODUCT	LENGTH - UP TO -
65PHG25-2200	2200mm
65PHG25-2400	2400mm
65PHG25-2500	2500mm
65PHG25-2700	2700mm
65PHG25-2800	2800mm
65PHG25-2900	2900mm
65PHG25-3000	3000mm

**65PH40**

## The 65PH40 is a Punched Hole grate design.

Manufactured from 316 marine grade the 65PH40 is 65mm wide and 40mm deep.

**316  
GRADE**

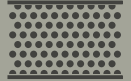

## Made-to-Length

All stainless steel drainage unit made to specified length with specified outlet position.

**Outlet Suits Pipe:** DN40 / DN50 / DN65

**PRODUCT**

**WIDTH x DEPTH**

**65PHi40MTL**

74mm x 42mm

## Modular Kits

Lengths over 3000mm available on request.



### 65PHi40

All Stainless Steel

**Outlet Suits Pipe:** DN50

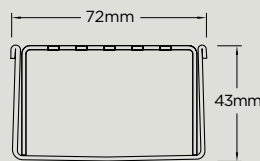

**MODULAR KIT**

PRODUCT	LENGTH - UP TO -
<b>65PHi40-0900</b>	900mm
<b>65PHi40-1000</b>	1000mm
<b>65PHi40-1200</b>	1200mm
<b>65PHi40-1500</b>	1500mm
<b>65PHi40-1800</b>	1800mm
<b>65PHi40-1900</b>	1900mm
<b>65PHi40-2000</b>	2000mm
<b>65PHi40-2100</b>	2100mm

PRODUCT	LENGTH - UP TO -
<b>65PHi40-2200</b>	2200mm
<b>65PHi40-2400</b>	2400mm
<b>65PHi40-2500</b>	2500mm
<b>65PHi40-2700</b>	2700mm
<b>65PHi40-2800</b>	2800mm
<b>65PHi40-2900</b>	2900mm
<b>65PHi40-3000</b>	3000mm



# 65 Range

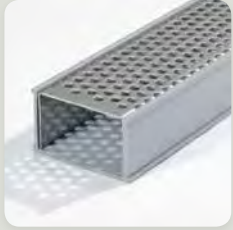

## 65PHG40

uPVC Channel + Fittings

Outlet Suits Pipe: DN40 / DN50

MODULAR KIT

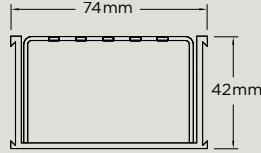

PRODUCT	LENGTH - UP TO -
<b>65PHG40-0900</b>	900mm
<b>65PHG40-1000</b>	1000mm
<b>65PHG40-1200</b>	1200mm
<b>65PHG40-1500</b>	1500mm
<b>65PHG40-1800</b>	1800mm
<b>65PHG40-1900</b>	1900mm
<b>65PHG40-2000</b>	2000mm
<b>65PHG40-2100</b>	2100mm

PRODUCT	LENGTH - UP TO -
<b>65PHG40-2200</b>	2200mm
<b>65PHG40-2400</b>	2400mm
<b>65PHG40-2500</b>	2500mm
<b>65PHG40-2700</b>	2700mm
<b>65PHG40-2800</b>	2800mm
<b>65PHG40-2900</b>	2900mm
<b>65PHG40-3000</b>	3000mm

# 38 Range

## Available Grate Styles



AR



PS

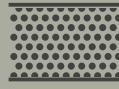

PH



The 38AR is a premium architectural grate design featuring a 2mm wire/2.5mm gap.

Manufactured from 316 marine grade the 38AR is 38mm wide and 40mm deep.



## Made-to-Length

All stainless steel drainage unit made to specified length with specified outlet position.

Outlet Suits Pipe: DN40

PRODUCT	WIDTH x DEPTH
38ARi40MTL	43mm x 42mm

## Modular Kits

Lengths over 3000mm available on request.



### 38ARG40

uPVC Channel + Fittings  
Outlet Suits Pipe: DN40 / DN50

MODULAR KIT

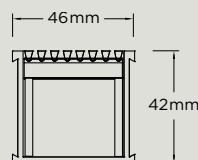

PRODUCT	LENGTH - UP TO -
38ARG40-1200	1200mm
38ARG40-1500	1500mm
38ARG40-2400	2400mm

PRODUCT	LENGTH - UP TO -
38ARG40-2700	2700mm
38ARG40-3000	3000mm

# 38 Range

**38PS**

## The 38PS is a Punched Slot grate design.

Manufactured from 316 marine grade the 38PS is 38mm wide and 40mm deep.

**316**  
GRADE



## Made-to-Length

All stainless steel drainage unit made to specified length with specified outlet position.

**Outlet Suits Pipe: DN40**

**PRODUCT**

**WIDTH x DEPTH**

**38PSi40MTL**

43mm x 42mm

## Modular Kits

Lengths over 3000mm available on request.



### 38PSG40

uPVC Channel + Fittings

**Outlet Suits Pipe: DN40 / DN50**

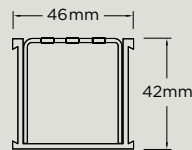

**MODULAR KIT**

PRODUCT	LENGTH - UP TO -
<b>38PSG40-0900</b>	900mm
<b>38PSG40-1000</b>	1000mm
<b>38PSG40-1200</b>	1200mm
<b>38PSG40-1500</b>	1500mm
<b>38PSG40-1800</b>	1800mm
<b>38PSG40-1900</b>	1900mm
<b>38PSG40-2000</b>	2000mm
<b>38PSG40-2100</b>	2100mm

PRODUCT	LENGTH - UP TO -
<b>38PSG40-2200</b>	2200mm
<b>38PSG40-2400</b>	2400mm
<b>38PSG40-2500</b>	2500mm
<b>38PSG40-2700</b>	2700mm
<b>38PSG40-2800</b>	2800mm
<b>38PSG40-2900</b>	2900mm
<b>38PSG40-3000</b>	3000mm



## The 38PH is a Punched Hole grate design.

Manufactured from 316 marine grade the 38PH is 65mm wide and 40mm deep.

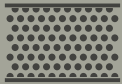

## Made-to-Length

All stainless steel drainage unit made to specified length with specified outlet position.

Outlet Suits Pipe: DN40

PRODUCT	WIDTH x DEPTH
<b>38PHi40MTL</b>	43mm x 42mm

## Modular Kits

Lengths over 3000mm available on request.



### 38PHG40

uPVC Channel + Fittings  
Outlet Suits Pipe: DN40 / DN50

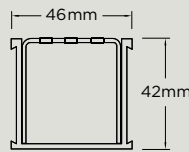

**MODULAR KIT**

PRODUCT	LENGTH - UP TO -
<b>38PHG40-0900</b>	900mm
<b>38PHG40-1000</b>	1000mm
<b>38PHG40-1200</b>	1200mm
<b>38PHG40-1500</b>	1500mm
<b>38PHG40-1800</b>	1800mm
<b>38PHG40-1900</b>	1900mm
<b>38PHG40-2000</b>	2000mm
<b>38PHG40-2100</b>	2100mm

PRODUCT	LENGTH - UP TO -
<b>38PHG40-2200</b>	2200mm
<b>38PHG40-2400</b>	2400mm
<b>38PHG40-2500</b>	2500mm
<b>38PHG40-2700</b>	2700mm
<b>38PHG40-2800</b>	2800mm
<b>38PHG40-2900</b>	2900mm
<b>38PHG40-3000</b>	3000mm

# Square Range

## Available Grate Styles



AR



TR



Ti

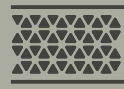

MND



PS

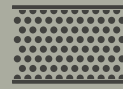

PH

**SQ**

Square drain units are manufactured from 316 marine grade stainless steel.

**316**  
GRADE

The SQ Range of floor waste units allow the integration of a standard floor waste with Stormtech linear drainage.

## Complete Square Units

### SQ100



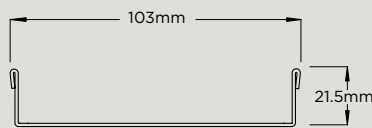

All Stainless Steel  
76mm / 38mm Outlet

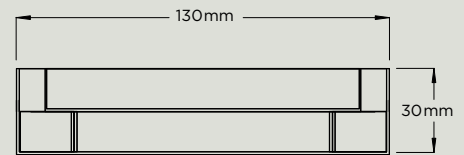

SQ100



SQ100Ti

PRODUCT	ITEM DESCRIPTION	PRODUCT	ITEM DESCRIPTION
	103mm x 103mm 21.5mm Deep Architectural Grate		103mm x 103mm 21.5mm Deep Marc Newson Design Grate  Also available in black or white finish
	103mm x 103mm 21.5mm Deep Standard Grate		103mm x 103mm 21.5mm Deep Punched Slot Grate
	130mm x 130mm 30mm Deep Tile Insert  Suitable for tiles up to 12mm thick		103mm x 103mm 21.5mm Deep Punched Hole Grate

# Threshold Range

## Available Grate Styles

\*ON REQUEST



AR



Ti



PS

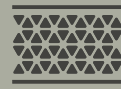

MND\*



TR\*



Featuring a linear stainless steel grate or tile insert with concealed channel section connecting sill and sub-sill for door tracks and thresholds.



Allows door sills to be drained while having internal and external floor surfaces with no step down.

## Sill + Sub-Sill Usage

### TDi



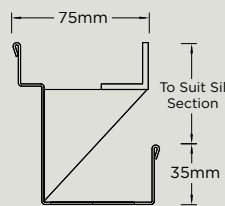

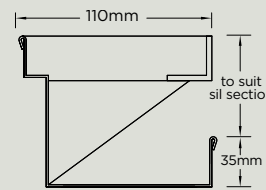

All Stainless Steel  
Finished to Custom Length



65TDi



100TDi

PRODUCT	ITEM DESCRIPTION	PRODUCT	ITEM DESCRIPTION
	65mm Wide Architectural Grate		100mm Wide Architectural Grate
<b>65ARTDi</b>		<b>100ARTDi</b>	
	65mm Wide Tile Insert		100mm Wide Tile Insert
<b>65TiTDi</b>		<b>100TiTDi</b>	
	65mm Wide Punched Slot Grate		100mm Wide Punched Slot Grate
<b>65PSTDi</b>		<b>100PSTDi</b>	



# Threshold Range

## Sill Only Usage

### TDiS

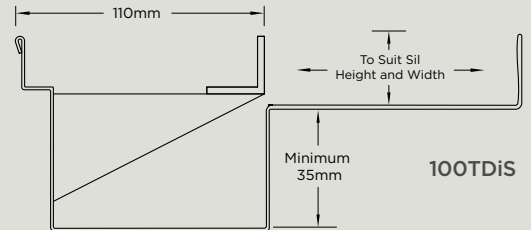
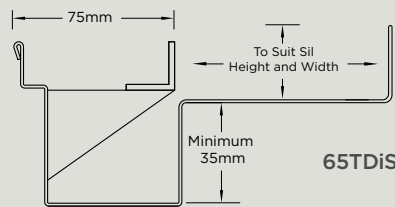
All Stainless Steel  
Finished to Custom Length

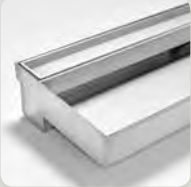

PRODUCT	ITEM DESCRIPTION
	65mm Wide Architectural Grate
	65mm Wide Tile Insert
	65mm Wide Punched Slot Grate

PRODUCT	ITEM DESCRIPTION
	100mm Wide Architectural Grate
	100mm Wide Tile Insert
	100mm Wide Punched Slot Grate

# Vinyl Clamp



Designed specifically for vinyl floor environments, the VC range of drain units are manufactured from 316 marine grade stainless steel.

**316  
GRADE**

Stainless steel vinyl clamp drainage unit for use in a vinyl floor environment.

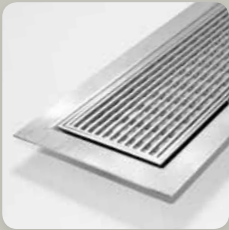

VC100-25

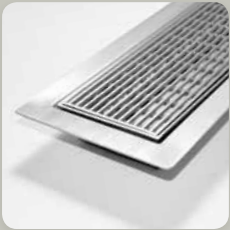

VC100-42



VC100-45

## Vinyl Clamp Units

Custom length drainage unit with specified outlet position.

All Stainless Steel

PRODUCT	ITEM DESCRIPTION
VC100-25	Width: 170mm Depth: 25mm
VC100-42	Width: 170mm Depth: 42mm
VC100-45	Width: 155mm Depth: 45mm

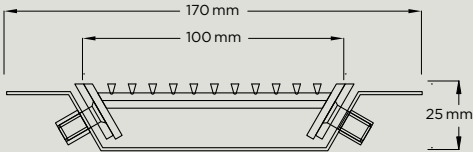

VC100-25

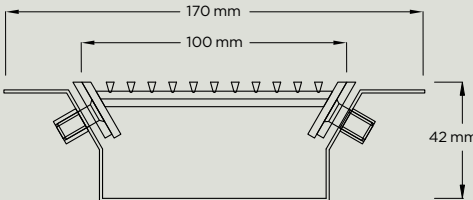

VC100-42

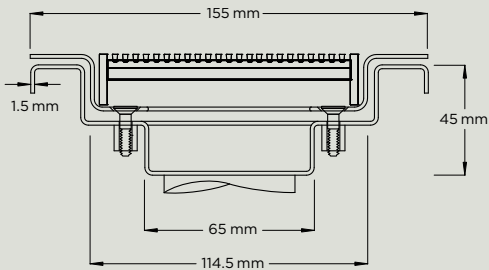

VC100-45



# Special Assembly

## Special Assembly

Developed for high capacity drainage needs, providing flexibility in landscape and pool design.

The Special Assembly Range features a drainage channel connected via downpipes at 200mm intervals to a drain pipe below.

## 65 Range Special Assembly



### 65G100 | 65G90

Add a 65mm grate from AR40, TR40, PS40 or PH40 to complete this system.

See Grates Below

PRODUCT	WIDTH x DEPTH
<b>65G100</b>	65mm wide channel and 100mm drain pipe assembly Length: 3000mm
<b>65G90</b>	65mm wide channel and 90mm drain pipe assembly Length: 3000mm

### 65AR40 GRATES Width: 65mm x Depth: 40mm



AR

PRODUCT	LENGTH	GRATE STYLE
<b>65AR40-1000</b>	1000mm	Architectural Grate
<b>65AR40-1500</b>	1500mm	Architectural Grate

### 65TR40 GRATES Width: 65mm x Depth: 40mm



TR

PRODUCT	LENGTH	GRATE STYLE
<b>65TR40-1000</b>	1000mm	Standard Grate
<b>65TR40-1500</b>	1500mm	Standard Grate

### 65PS40 GRATES Width: 65mm x Depth: 40mm



PS

PRODUCT	LENGTH	GRATE STYLE
<b>65PS40-1000</b>	1000mm	Punched Slot Grate
<b>65PS40-1500</b>	1500mm	Punched Slot Grate

### 65PH40 GRATES Width: 65mm x Depth: 40mm

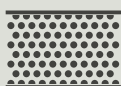

PH

PRODUCT	LENGTH	GRATE STYLE
<b>65PH40-1000</b>	1000mm	Punched Hole Grate
<b>65PH40-1500</b>	1500mm	Punched Hole Grate

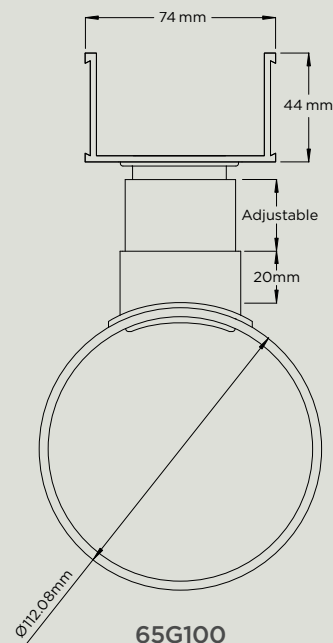

65G100

# Special Assembly

## 38 Range Special Assembly



### 38G90 | 38G100

Add a 38mm grate from AR40, PS40 or PH40 to complete this system.

See Grates Below

PRODUCT	DESCRIPTION
<b>38G90</b>	38mm wide channel and 90mm drain pipe assembly Length: 3000mm
<b>38G100</b>	38mm wide channel and 100mm drain pipe assembly Length: 3000mm

### 38AR40 GRATES Width: 38mm x Depth: 40mm



AR

PRODUCT	LENGTH	GRATE STYLE
<b>38AR40-1200</b>	1200mm	Architectural Grate
<b>38AR40-1500</b>	1500mm	Architectural Grate

### 38PS40 GRATES Width: 38mm x Depth: 40mm



PS

PRODUCT	LENGTH	GRATE STYLE
<b>38PS40-1000</b>	1000mm	Punched Slot Grate
<b>38PS40-1500</b>	1500mm	Punched Slot Grate

### 38PH40 GRATES Width: 38mm x Depth: 40mm

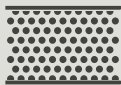

PH

PRODUCT	LENGTH	GRATE STYLE
<b>38PH40-1000</b>	1000mm	Punched Hole Grate
<b>38PH40-1500</b>	1500mm	Punched Hole Grate

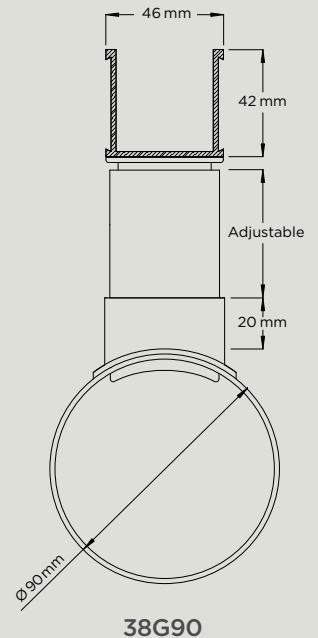

38G90

# Slot Drain

Available  
Grate Styles



AR

SD

The SD90 features a 25mm opening on the top with 20 slots draining into a concealed 90mm drain pipe.

The Slot Drain can be completed with a 30mm wide architectural wedge-wire grate as an optional item.

## Slot Drain Components

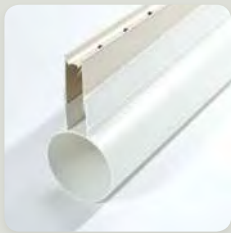

Slot Drain



SDiAR

PRODUCT	ITEM DESCRIPTION
<b>SD90</b>	90mm Drain with UPVC Beige Insert (no holes) Length: 3000mm
<b>SDi</b>	Replacement Slot Drain Insert (no holes) Length: 3000mm
<b>SDH</b>	10mm Holes at 50mm centres Length: per 3000mm
<b>SDJ</b>	Slot Drain Joiner
<b>SDiAR</b>	Wedgewire Stainless Steel Grate 30mm Wide to Fit SD90 Length: Custom (per metre)

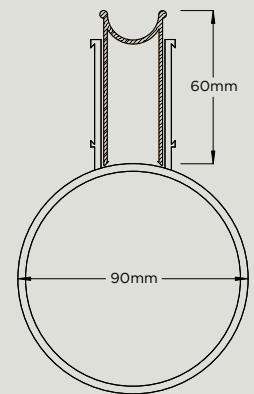

SD90

# Custom Fabrication

## Available Grate Styles



AR



TR



Ti

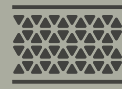

MND

**Custom  
Made**

For site specific needs or unusual situations, choose from our Custom Fabrication range.

Stormtech can customise any drainage requirements to achieve maximum efficiency.

316  
GRADE

304  
GRADE

## Custom Items

PRODUCT	ITEM DESCRIPTION
<b>50ARi</b>	Up to 50mm wide drainage unit   Depth: 20mm - 40mm
<b>65ARi</b>	51mm - 65mm wide drainage unit   Depth: 20mm - 40mm
<b>75ARi</b>	66mm - 75mm wide drainage unit   Depth: 20mm - 50mm
<b>100ARi</b>	76mm - 100mm wide drainage unit   Depth: 20mm - 100mm
<b>200CUSTOM</b>	101mm - 200mm wide drainage unit   Depth: 20mm - 200mm
<b>300CUSTOM</b>	201mm - 300mm wide drainage unit   Depth: 20mm - 200mm
<b>Custom</b>	Fully Customised Drainage Unit: Width, Depth, Length, Outlet Size and Position
<b>100ARiMTLF</b>	100AR grate and channel with tiling flanges
<b>65ARiMTLF</b>	65AR grate and channel with tiling flanges
<b>100TiMTLF</b>	100 Tile insert and channel with tiling flanges
<b>65TiMTLF</b>	65 Tile insert and channel with tiling flanges
<b>100PSiMTLF</b>	100PS grate and channel with tiling flanges
<b>65PSiMTLF</b>	65PS grate and channel with tiling flanges
<b>100TRiMTLF</b>	100TR grate and channel with tiling flanges
<b>65TRiMTLF</b>	65TR grate and channel with tiling flanges
<b>100FTi25MTL</b>	100 Flat Top grate and channel   Depth: 27mm o/a
<b>65FTi25MTL</b>	65 Flat Top grate and channel   Depth: 27mm o/a
<b>Threaded Outlet</b>	Male 50.8mm Threaded Outlet

# Hydraulic Guide

## Flow Rates

Refer to AS3500 for required outlet and pipe sizing appropriate to your application.

Please note this table is supplied as a guide only. For critical performance, always consult a hydraulic engineer.

## Hydraulic Table

Lateral flow rate is the flow rate along the channel towards the outlet or open end.

All flow rates specified for spigots are vertical flow rates.

CHANNEL	LATERAL FLOW RATE	DN40 SPIGOT	DN50 SPIGOT	DN80 SPIGOT	DN100 SPIGOT
38mm x 40mm	0.4 L/s	0.5 L/s	-	-	-
65mm x 40mm	0.7 L/s	0.5 L/s	1.0 L/s	-	-
65mm x 25mm	0.4 L/s	0.5 L/s	0.5 L/s	-	-
100mm x 20mm	0.4 L/s	0.5 L/s	0.5 L/s	0.5 L/s	0.5 L/s
100mm x 30mm	0.6 L/s	0.5 L/s	0.8 L/s	1.0 L/s	1.0 L/s
100mm x 40mm	0.9 L/s	0.5 L/s	1.0 L/s	1.0 L/s	1.1 L/s

## Examples

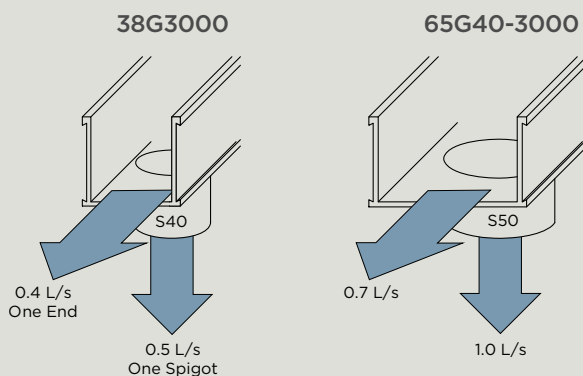

## Stormtech Product Care

Stormtech stainless steel requires minimal attention and will not tarnish or corrode under normal circumstances.

Exposure to certain chemical or environmental conditions may, over time, promote surface oxidation. Please be aware this is not a defect in the stainless steel but a reaction on the surface of the finish to the chemical environment, which can be removed with a stainless steel polish.

## Environmental Conditions

Individual sites and situations vary dramatically. Areas close to salt water, particularly breaking surf are severe corrosion environments. Particular care is required to maintain the stainless steel.

Visit **stormtech.com.au**  
for detailed assembly  
and installation information.

### Technical Drawings

We provide complete CAD files  
for download from our website.

### Distributors + Stockists

To find a distributor near you, please visit our  
website or call our office.

**Stormtech** Pty Ltd

Telephone 1300 653 403 | [www.stormtech.com.au](http://www.stormtech.com.au)